



FORTY SIX - FIFTY FOUR
OSSINGTON AVENUE



NEW CHARACTER RETAIL FOR LEASE ON OSSINGTON AVE

CBRE



[CLICK HERE FOR DRONE VIDEO](#)

hullmark



FULL BUILDING RENOVATION
NEARING COMPLETION

Offering

Net Rent: Please contact listing agents

Additional Rent: \$20.00 per sq. ft. (estimate for 2020)

Availability: Q4 2020

	46 Oss	48 Oss	50 Oss	52 Oss	54 Oss
Basement:	900 sf	900 sf	900 sf	900 sf	900 sf
Ground:	1,225 sf	1,225 sf	1,425 sf	1,225 sf	1,175 sf
Second:	na	na	1,000 sf	1,000 sf	950 sf
Third:	na	na	800 sf	500 sf	500 sf
Total:	2,125 sf	2,125 sf	4,125 sf	3,625 sf	3,525 sf

Third Floor Patios:

50 Ossington: ~100 sf | 52 Ossington: ~250 sf | 54 Ossington: ~250 sf

Highlights

- Full building renovation currently underway with 5 character retail units.
- Ground floor retail units feature double-height rear additions.
- Potential for full building lease.
- Prime retail located on Ossington Avenue in proximity to over 265,000 residents and over 5 million SF of office.
- Toronto's most electric restaurant and bar scene featuring La Banane, Mamakas, Bellwoods Brewery & Union.
- The area is a well curated retail node with Reigning Champ, Fred Perry, Aesop, Nadege, Le Labo, gravitypope, Burton, Ollie Quinn and Tiger of Sweden as key tenants.



[Click here for more information and additional images](#)

Interior Renderings



Floor Plans

Basement Floor Plan

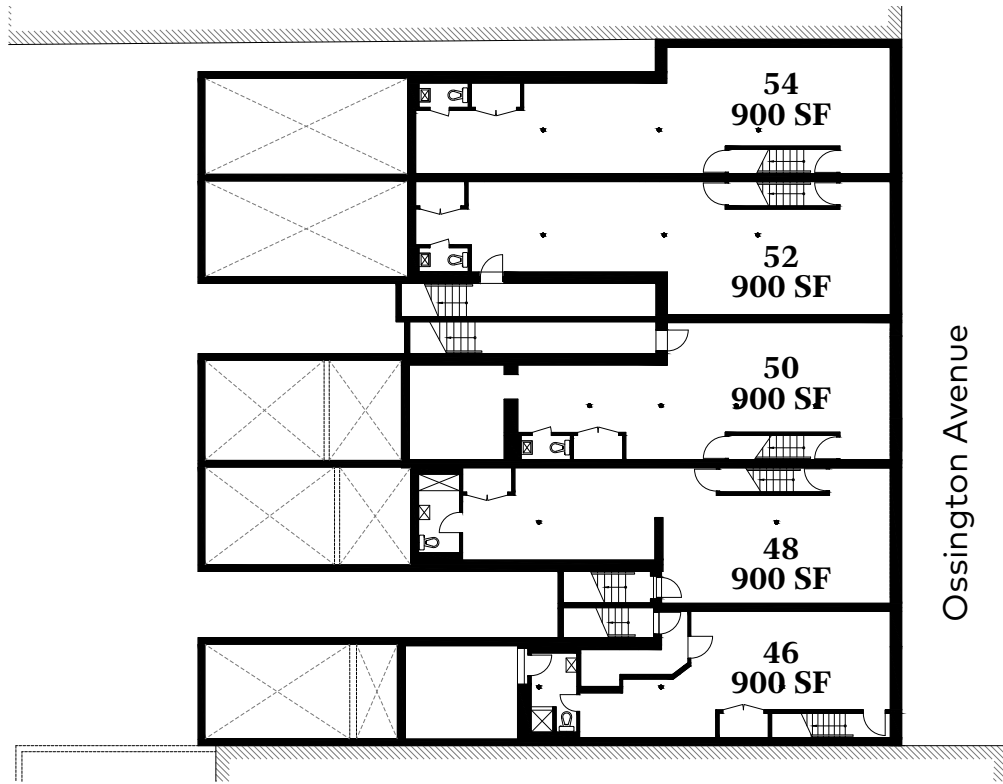

Second Floor Plan

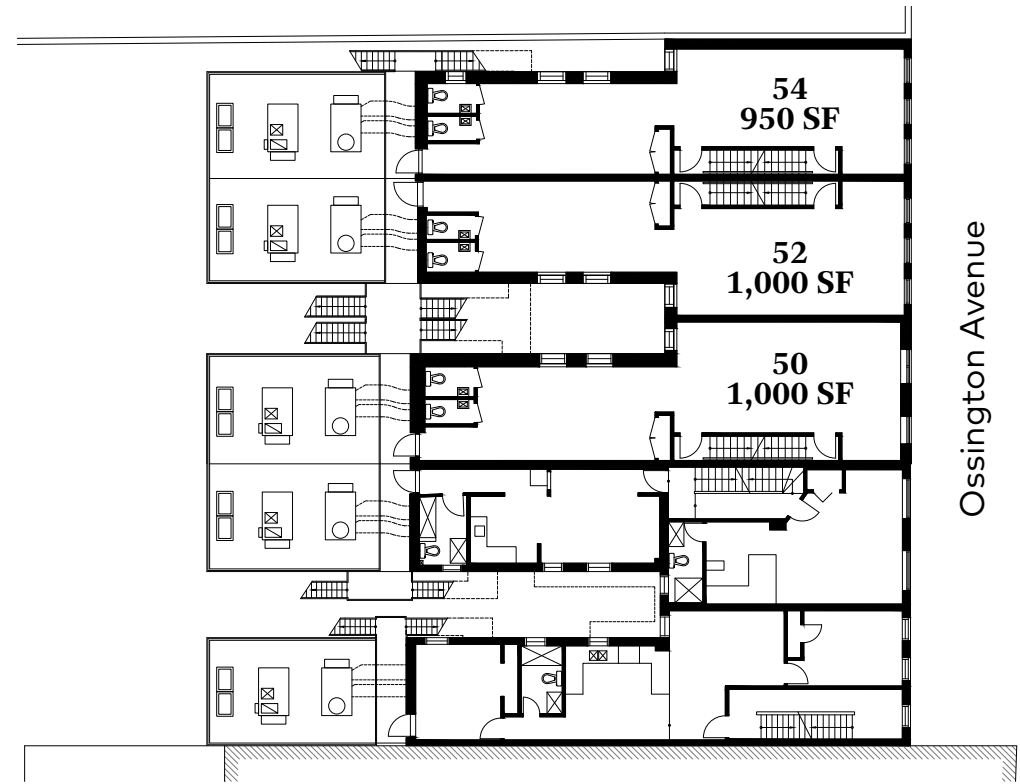

Ground Floor Plan

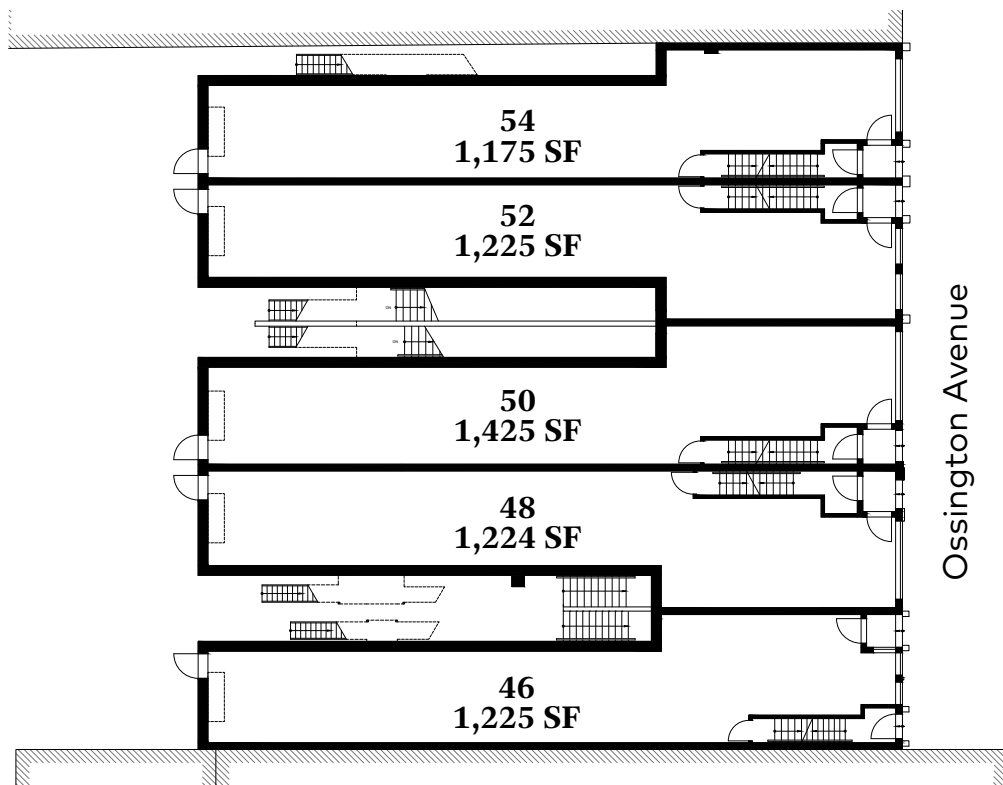

Third Floor Plan

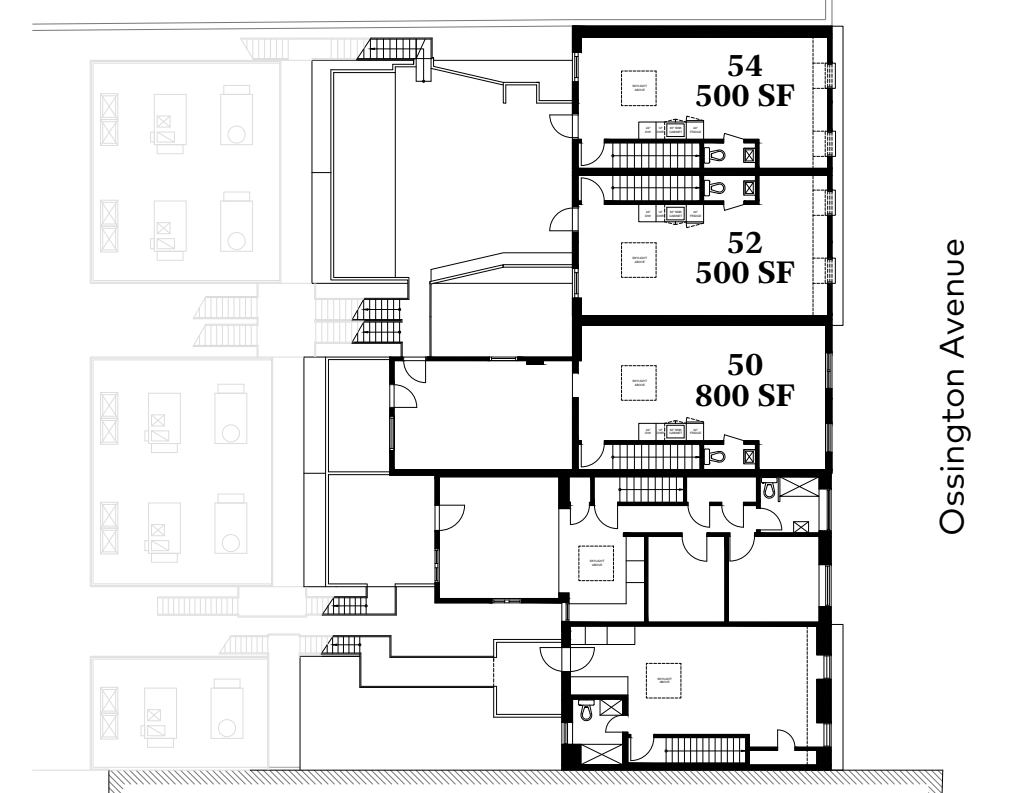



FINANCIAL CORE

DOWNTOWN WEST OFFICE/
ENTERTAINMENT DISTRICT

LIBERTY VILLAGE

505 Dundas
Streetcar

TRINITY BELLWOODS
PARK

WEST QUEEN WEST

46-54
OSSINGTON
AVENUE

257,603
Population

7%
Population Change
(2018-2019)

34.3
Median Age

\$113,400
Average Household Income

501 Queen
Streetcar

Streetscape Map

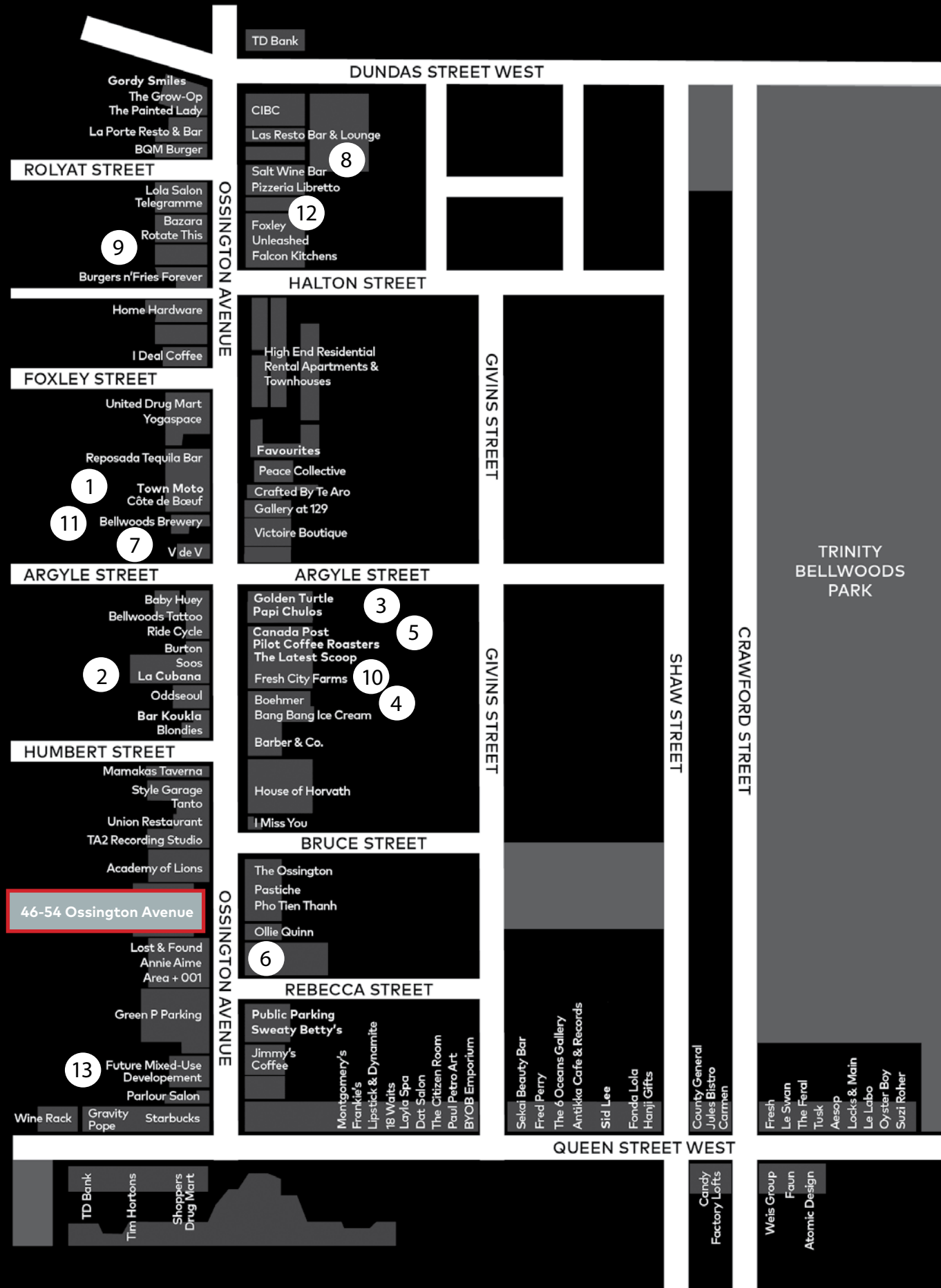

Ossington



Here Here, a neighbourhood magazine published in 2019 by Hullmark in collaboration with Public Address. They interviewed and documented the people, buildings and businesses that define the Ossington community.



1
Doubleknaut Design
 134 Ossington



3
Golden Turtle Restaurant
 125 Ossington



2
La Cubana
 92 Ossington

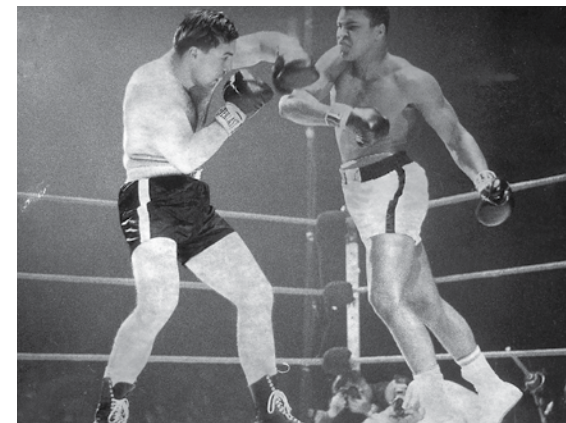

4
Muhammad Ali vs George Chuvalo
 109 Ossington

In March 1966, Muhammad Ali trained at 109 Ossington to fight Toronto-born George Chuvalo for the World Boxing Council heavyweight championship at Maple Leaf Gardens.

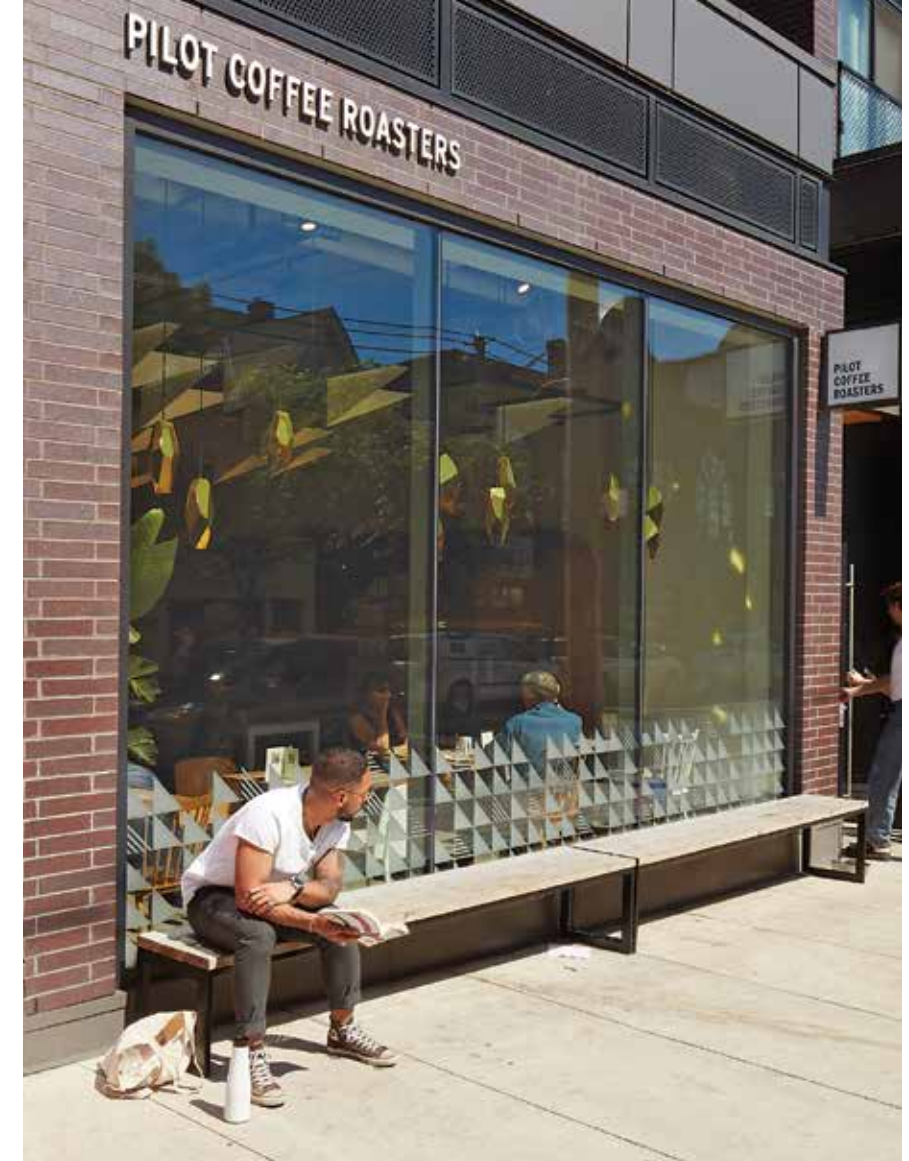

5
Pilot Coffee Roasters
 117 Ossington



6
Reigning Champ
 41 Ossington

"Here we're made up of so many different cultures and I think that contributes to our openness to try new things."

Brandon Olsen
La Banane
92 Ossington

8



7

V de V
120 Ossington

9

Favorites / Superpoint
141 & 184 Ossington



10

Fresh City Farms
111 Ossington



11

Bellwoods Brewery
124 Ossington



13

Fire Hall No.9, 1955
(Courtesy of Toronto Public Library)



13

12 Ossington
Designed by Hariri Pontarini Architects

"Ossington is an old street that carries a lot of history. History can be seen in its old brick buildings and industrial charm."

Gianpiero Pugliese
Audax Architecture

12



Retail Advisory Team

Arlin Markowitz*

Senior Vice President

Urban Retail Team

t: 416.815.2374

arlin.markowitz@cbre.com

Alex Edmison*

Senior Vice President

Urban Retail Team

t: 416.874.7266

alex.edmison@cbre.com

Jackson Turner**

Vice President

Urban Retail Team

t: 416.815.2394

jackson.turner@cbre.com

Teddy Taggart*

Senior Sales Associate

Urban Retail Team

t: 416.847.3254

teddy.taggart@cbre.com

Selina Tao

Sales Representative

Urban Retail Team

t: 416 815 2396

selina.tao@cbre.com

*Sales Representative, **Broker

CBRE

This disclaimer shall apply to CBRE Limited, Real Estate Brokerage, and to all other divisions of the Corporation; to include all employees and independent contractors ("CBRE"). The information set out herein, including, without limitation, any projections, images, opinions, assumptions and estimates obtained from third parties (the "Information") has not been verified by CBRE, and CBRE does not represent, warrant or guarantee the accuracy, correctness and completeness of the Information. CBRE does not accept or assume any responsibility or liability, direct or consequential, for the Information or the recipient's reliance upon the Information. The recipient of the Information should take such steps as the recipient may deem necessary to verify the Information prior to placing any reliance upon the Information. The Information may change and any property described in the Information may be withdrawn from the market at any time without notice or obligation to the recipient from CBRE. CBRE and the CBRE logo are the service marks of CBRE Limited and/or its affiliated or related companies in other countries. All other marks displayed on this document are the property of their respective owners. All Rights Reserved.